

# Wallpaper OLED Signage - 55EJ5D

## Engaging Spaces Beyond Displays



LG's OLED Wallpaper Signage is surprisingly slim, light and space saving. Providing an extraordinary customer experience is second nature to OLED Wallpaper; upgrading virtually any space. It also can be used as a video wall when easily attached to the wall with the included wall mount.

### Why OLED Technology?



#### Perfect Black

##### Limitless contrast and deepest black

Self-lighting pixels switch off completely to reproduce black. No light bleeding. Absolute black offers infinite contrast.



LCD

LG OLED Signage



#### Amazing color

##### Accurate & stable color reproduction

Self-lighting pixels bring colors to life with superb accuracy.

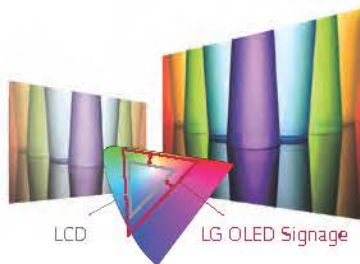

LCD

LG OLED Signage



#### Perfect Viewing Screen

##### Wide viewing angle

LG OLED Signage delivers awe-inspiring picture quality across the entire screen, even from wide viewing angles.



LCD

LG OLED Signage



#### Crisp, Clear Motion

##### Faster response time

LG OLED Signage provides a 5,000-times faster motion-picture response time, for perfectly clear images without blurring.



LCD

LG OLED Signage



#### Perfect Design

##### Slim and light

With just two layers, the LG OLED Signage display is unbelievably lightweight and thin.



LCD  
86.5 mm  
18.6 kg

VS

LG OLED Signage  
3.65 mm\*  
12.6 Kg

\* Edge depth

# Artistic Space Beyond Display

## 55EJ5D wallpaper OLED signage



### Screen Size

55"

### 55EJ5D

- Brightness : 400 cd/m<sup>2</sup> (APL 25%)
- Bezel: 1.2 mm (Off bezel)
- Depth: 3.65 mm (Module)
- Interface: HDMI, DP, RS232C, RJ45, IR In, USB 3.0, USB 2.0
- SuperSign Premium / Link



## Key Features

### Hide in Plain Sight

Its paper-thin depth gives the space an integrated look.

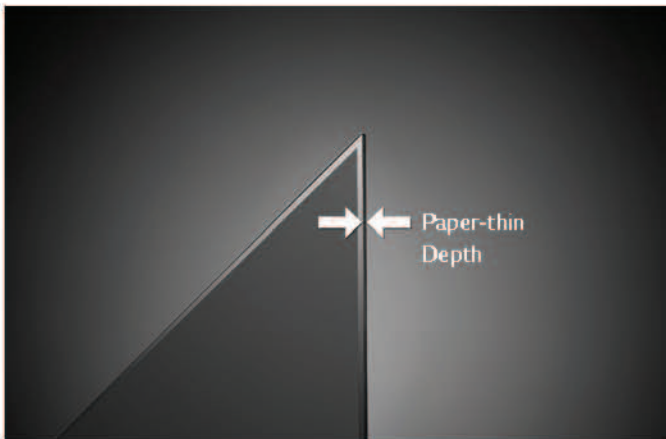

### Easy Installation & Video-Wall Tiling

As LG wallpaper OLED signage is extremely slim and light, it can be hung on the wall with dedicated slim brackets for video-wall usage.



## Specifications

|                            |   | 55EJ5D  |
|----------------------------|---|---|
| PANEL                      | Screen Size   | 55" (54.64" diagonal)   |
|                            | Panel Technology  | OLED  |
|                            | Aspect Ratio  | 16:9  |
|                            | Native Resolution   | 1,920 x 1,080 (FHD)   |
|                            | Brightness  | 100/400 cd/m <sup>2</sup> (APL 100% / 25%) * Average picture level  |
|                            | Dynamic CR  | 100,000:1   |
|                            | Viewing Angle (H x V)   | 178 x 178   |
|                            | Response Time   | 1 ms (G to G), 8 ms (MPRT)  |
|                            | Surface Treatment   | Hard coating (2H), Anti-reflection treatment of the front polarizer (Reflectance typ. 1.0%)   |
|                            | Guaranteed Operating Hours  | 18 hrs/7 days (Moving video only)   |
| Orientation                | Landscape & Portrait  |   |
| CONNECTIVITY               | Input   | HDMI, DP  |
|                            | Output  | DP, Audio   |
|                            | External Control  | RS232C in/out, RJ in/out, IR Receiver, USB 2.0, USB 3.0   |
| PHYSICAL SPECIFICATION     | Bezel Color   | Black   |
|                            | Bezel Width   | 1.2, 1.2, 1.2, 1.2 mm (U, B, L, R *Offset bezel)  |
|                            | Dimension (W x H x D)   | Head: 1,227 x 702.1 x 3.65 mm, Signage Box: 420 x 230 x 75 mm   |
|                            | Weight  | Head: 5.5 kg, Signage Box: 5.3 kg, Wall Bracket: 1.8 kg   |
|                            | Carton Dimensions (W x H x D)   | 54.4" x 32.8" x 9.9"  |
|                            | Packed Weight   | 49.6 lbs  |
| SPECIAL FEATURES           | Temperature Sensor, Cooling FAN, Source Selection, DPM Select, Energy Saving, Motion Eyecare, File Play with USB, Internal Memory (64 GB), Wi-Fi Dongle Ready, USB Cloning, Contents Scheduling, Local Time Auto Setting, Failover, Mirroring, SoftAP, BEACON, DP daisy chain |   |
| ENVIRONMENT CONDITIONS     | Operation Temperature   | 32°F to 104° F  |
|                            | Operation Humidity  | 10% to 80%  |
| POWER                      | Power Supply  | 100-240 V~, 50/60 Hz  |
|                            | Power Type  | Built-in Power  |
| POWER CONSUMPTION          | Typ.  | 190 W   |
|                            | DPM   | Less than 3 W   |
|                            | Power off   | Less than 0.5 W   |
| STANDARD (CERTIFICATION)   | Safety  | UL/cUL/CB/TUV/KC  |
|                            | EMC   | FCC Class "A"/CE/KCC  |
|                            | ErP/Energy Star   | Yes/NA  |
| MEDIA PLAYER COMPATIBILITY | OPS-Type Compatible   | Yes   |
|                            | External Media Player Attachable  | Yes   |
| SOFTWARE COMPATIBILITY     | Content Management Software   | SuperSign Premium   |
|                            | Control and Monitoring Software   | SuperSign Link  |
| ACCESSORIES                | Basic   | Remote controller (includes 2 batteries), FPC Extension cable (connection between screen and signage box), Power cord, DP cable, RS-232C cable, RS-232C gender, LAN cable, IR receiver, Manual (ESG, EIG), Wall-mount plate (includes screws), Harness locking cover, Set install guide, Signage box bracket (U-Leg), FPC cable cover |
|                            | Optional  | OPS Kit (KT-OPSA)   |

## Dimension

### Display

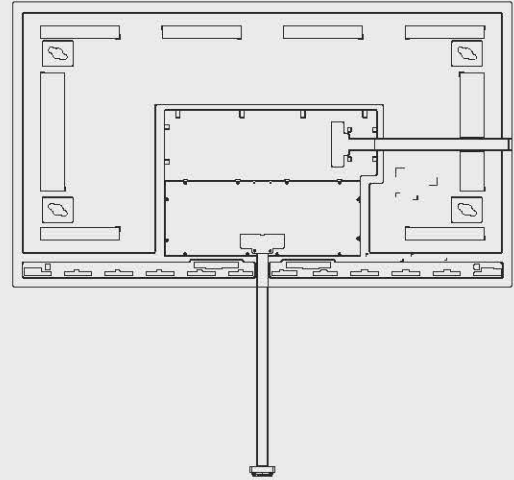
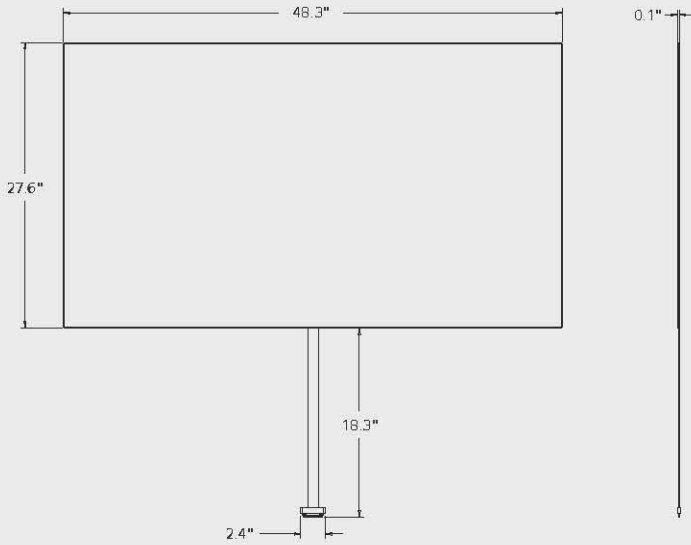

### Signage Box

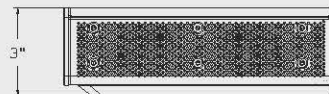
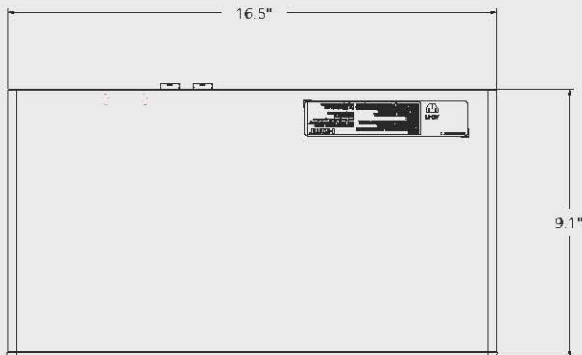

## Connectivity

- ① USB 2.0
- ② HDMI
- ③ DP in
- ④ DP out
- ⑤ USB 3.0
- ⑥ LAN in
- ⑦ LAN out
- ⑧ IR in
- ⑨ RS232C in
- ⑩ RS232C out
- ⑪ Audio out

55EJ5D

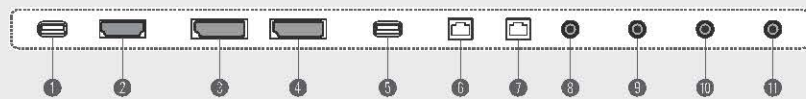

Download LG Commercial Display Mobile App



Learn more [www.lg.com/b2b](http://www.lg.com/b2b)

**YouTube** [youtube.com/c/LGCommercialDisplay](https://youtube.com/c/LGCommercialDisplay)

LG may make changes to specifications and product descriptions without notice.  
 Copyright © 2017 LG Electronics Inc. All rights reserved. "LG Life's Good" is a registered trademark of LG Corp.  
 The names of products and brands mentioned here may be the trademarks of their respective owners.  
 SPEC\_55EJ5D\_081746\_PR

